



ringa

LITPA



ringa

LITPA

RINGA, which particularly is preferred in the areas of residences, walking paths and Parks & Gardens, has been designed with the purpose of bringing difference to outside environment applications thanks to its curved design which also makes Ringa aesthetically pleasing. Energy savings and high performance have been prioritized in Ringa LED luminaires.

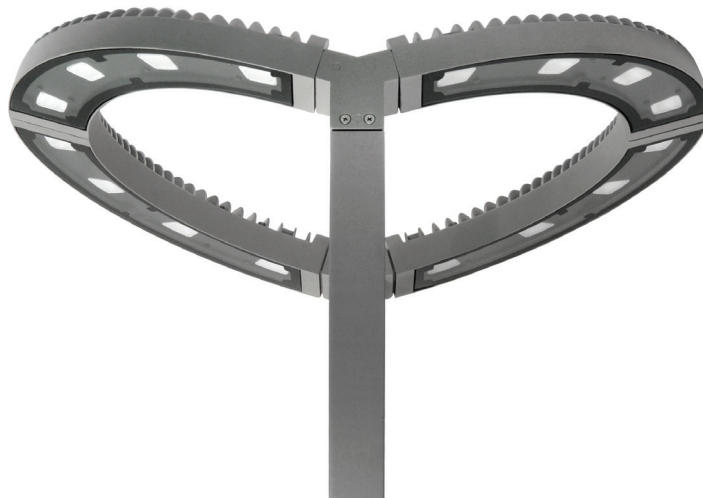

du ra ble

Walk ways-
Pedestrian Areas

RNY2



RNY4



- Body:** Aluminum injection painted with electrostatic paint
- LED:** High efficient Multi-Power Led
- Cooler:** Cooling from the surface of the aluminum body
- Optic:** High efficient lenses; 21°-26°-45°-65° or Reflectors; 21° - 30° - 63° - 90°
- Glass:** Transparent tempered glass, ground with serigraphic printing
- Voltage:** 220VAC
- Colour:** Grey or RAL colour

Code	LED Type	Luminous Flux	System Power	Colour Temperature	Weight	Box Dimensions
RNY 2/40	Multi-Power LED	3.500 lm	40 W	3000-4000-5000 K	9.8kg	70X65X35 cm
RNY 2/70	Multi-Power LED	6.500 lm	70 W	3000-4000-5000 K	12.8kg	70X65X70 cm
RNY 4/80	Multi-Power LED	7.300 lm	80 W	3000-4000-5000 K	12.8kg	70X65X70 cm
RNY 4/140	Multi-Power LED	12.670 lm	140 W	3000-4000-5000 K	12.8kg	70X65X70 cm
RNY 4/250	Multi-Power LED	25.760 lm	250 W	3000-4000-5000 K	12.8kg	70X65X70 cm
RNY 4/300	Multi-Power LED	28.870 lm	300 W	3000-4000-5000 K	12.8kg	70X65X70 cm

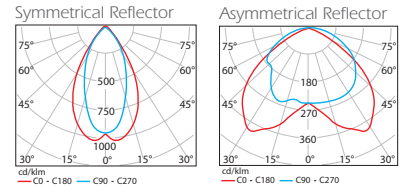
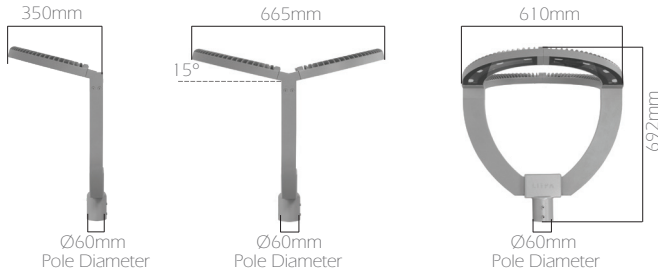

powerful

Agora

RNY/T2



RNY/T4

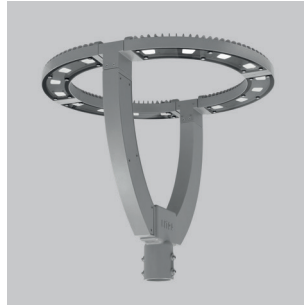

- Body:** Aluminum injection painted with electrostatic paint
- LED:** High efficient Multi-Power Led
- Cooler:** Cooling from the surface of the aluminum body
- Optic:** High efficient lenses; 21°-26°-45°-65° or Reflectors; 21° - 30° - 63° - 90°
- Glass:** Transparent tempered glass, ground with serigraphic printing
- Voltage:** 220VAC
- Colour:** Grey or RAL colour

Code	LED Type	Luminous Flux	System Power	Colour Temperature	Weight	Box Dimensions
RNY/T4/250	Multi-Power LED	25.900 lm	250 W	3000-4000-5000 K	12.8kg	70X65X70 cm
RNY/T4/300	Multi-Power LED	28.900 lm	300 W	3000-4000-5000 K	12.8kg	70X65X70 cm

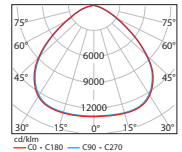

ver sa tile

Outdoor
Wall Lighting

RNW1



RNW2

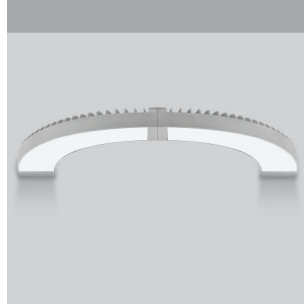

- Body:** Aluminum injection painted with electrostatic paint
- LED:** High efficient Mid-Power Led
- Cooler:** Cooling from the surface of the aluminum body
- Diffuser:** Acrylic opal - homogeneous symmetrical light distribution
- Voltage:** 220 - 240 VAC

RNW3

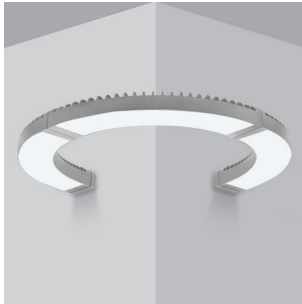

Code	LED	Luminous Flux	System Power	Colour Temperature	Weight
RNW1	Mid-Power LED	1.200lm	15W	3000-4000-5000-6500 K	2,3kg
RNW2	Mid-Power LED	2.400lm	30W	3000-4000-5000-6500 K	3,8kg
RNW3	Mid-Power LED	3.600lm	45W	3000-4000-5000-6500 K	5,3kg

RNW1

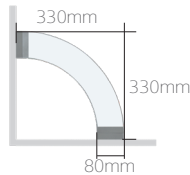

RNW2

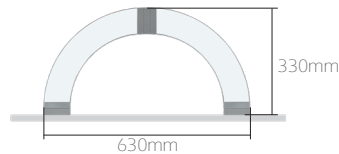

RNW3

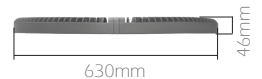
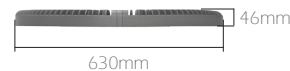
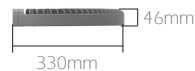
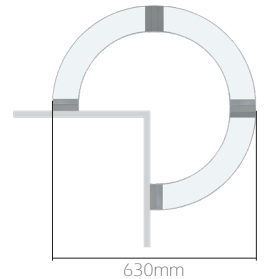

**in
no
va
tive**

Outdoor
Wall Lighting

RNW/S1



RNW/S2

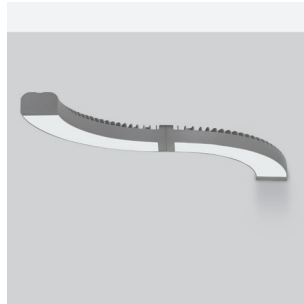

- Body:** Aluminum injection painted with electrostatic paint
- LED:** High efficient Mid-Power Led
- Cooler:** Cooling from the surface of the aluminum body
- Diffuser:** Acrylic opal - homogeneous symmetrical light distribution
- Voltage:** 220 - 240 VAC

Code	LED	Luminous Flux	System Power	Colour Temperature	Weight
RNW/S1	Mid-Power LED	1.200lm	15W	3000-4000-5000-6500 K	2,3kg
RNW/S2	Mid-Power LED	2.400lm	30W	3000-4000-5000-6500 K	3.8kg

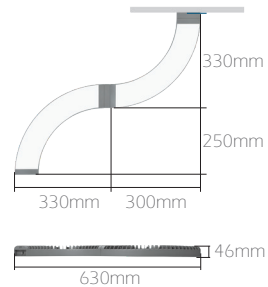

flex

ib

ible

Pendant Lighting

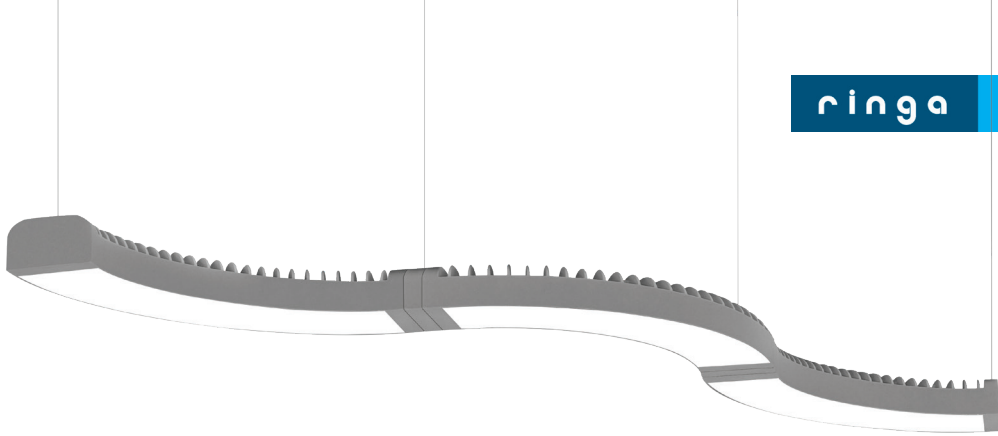

RNS

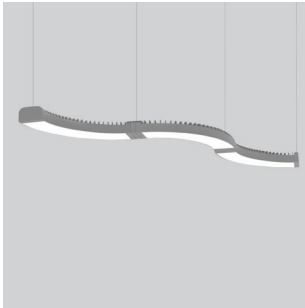

- Body:** Aluminum injection, painted with electrostatic paint
- LED:** High efficient Mid-Power Led
- Cooler:** Cooling from the surface of the aluminum body
- Diffuser:** Acrylic opal - homogeneous symmetrical light distribution
- Voltage:** 220 - 240 VAC

Code	LED	Luminous Flux	System Power	Colour Temperature	Weight
RNS	Mid-Power LED	3.600lm	45W	3000-4000-5000-6500 K	5,3kg

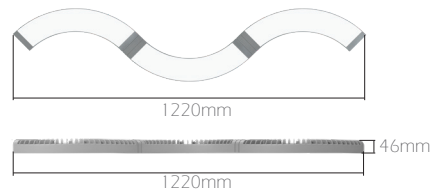

effi

ci

ent

LED

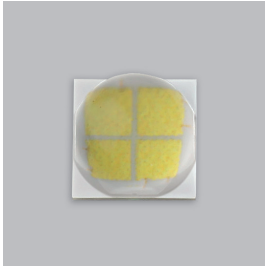

Multi-Power Led

- Minimum heating with special design (1.2 °C/W)
- Different colour temperatures (4.000 K - 5.000 K - 6.500 K)
- High color rendering (70 - 80 – 90 CRI)
- @ 85 °C LM 80-08 test report
- ≥ 50.000hrs economical life as IESNA TM-21
- 3-step MacAdam Ellipse
- Exceeds ENERGY STAR® lumen maintenance requirements

Mid-Power Led

- High color rendering (70 - 80 – 90 CRI)
- Driver max current @120mA
- @ 85 °C LM 80-08 test report
- ≥ 50.000hrs economical life as IESNA TM-21
- 3-step MacAdam Ellipse
- Exceeds ENERGY STAR® lumen maintenance requirements

DRIVER



- 198V- 264VAC operating range
- Power Factor Cos ϕ >0,95
- Efficiency >85%
- (THD) <10%
- Short circuit, open circuit, overload, over-heating protected
- RI suppression EN 55015
- Mains harmonics EN 61000-3-2
- Optional: 1-10 VOLT, DALI control systems

OPTICS



- Optical material: HPPC
- Thanks to its extra diffuse structure, the glare values are enabled to be minimal.
- High efficient
- Symmetrical or asymmetrical light distribution

re

li

able

In addition, high performance products achieve savings on energy at the highest level and increase on natural resource use at the lowest level.

As a result of quality policy that our company has carried out for years, all our products are tested in pursuant to quality standards and performance criteria.

In Ringa luminaire series, a number of factors such as the ability to perform the requirements of high protection class, being able to protect nominal working environment, electrical examination, material test and etc. are supervised.

Thanks to the high material quality and strict quality control processes, Ringa luminaire series are produced at the level which meets the most well-known and reliable world standards.

QUALITY

A hand with the index finger pointing upwards towards the word 'QUALITY'. The background is a dark blue field with a grid of small dots and several bright, out-of-focus light sources (bokeh) in shades of blue and white. A faint white plus sign is visible on the right side of the image.

LİTPA LIGHTING COMPANY

Haraççı - Hadımköy Yolu Cad.
No:15 Haraççı Mah. Arnavutköy
İstanbul / TURKEY

Phone: +90 212 683 09 87

Fax: +90 212 683 09 92

www.litpa.com