

Ölçüler milimetredir.
Dimensions in millimeters.

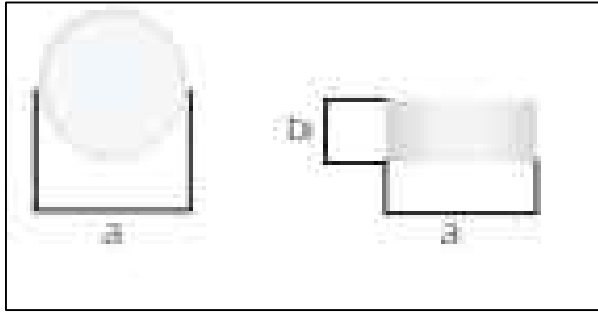

Kod	a	b
FNSS-Y 30	260 mm	100 mm

Notlar / *Notes*

Bu armatür bina içi kullanımına uygundur.

This luminaire is suitable for indoor use.

Bu armatürün harici bükülgel kablo veya kordonunun hasar görmesi durumunda; bir tehlike meydana gelmesini engellemek için yalnızca imalatçı veya onun yetkili servisi ya da eşgeğer nitelikte kalifiye personel tarafından değiştirilmesi gerekir.

If the external flexible cable or cord of this luminaire is damaged, it shall be exclusively replaced by the manufacturer or his service agent or a similar qualified person in order to avoid a hazard.

LİTA AYDINLATMA SAN. VE TİC. LTD. ŞTİ.

LİTA LIGHTING CO.

MERKEZ (**HEAD OFFICE**) : Koza Plaza B Blok Kat 6 No:20 Tekstilkent - ESENLER - İSTANBUL - TURKEY
TEL : 90 (0) 212 438 09 58 (Pbx) FAX : 90 (0) 212 438 09 57

FABRİKA (**FACTORY**) : Haraççı Hadımköy yolu Cad. No:15 Haraççı Mah. Arnavutköy / İSTANBUL - TURKEY
TEL : 90 (0) 212 683 09 87 (5 Hat) FAX : 90 (0) 212 683 09 92

www.litpa.com

L İ T P A

FNSS-Y ARMATÜRLERİ **FNSS-Y Luminaires**

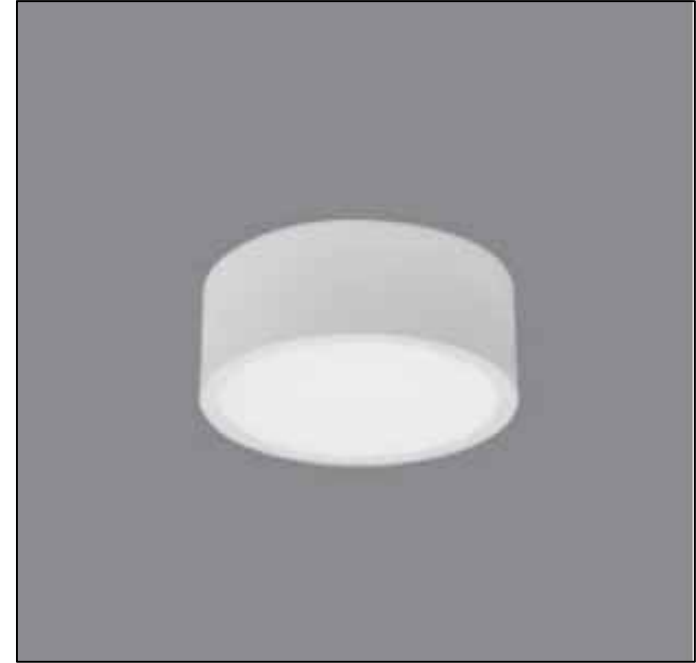

Aydınlatmada dünya markası olma yolunda bir Türk markası olan

LİTA Aydınlatma'yı tercih ettiğiniz için teşekkür ederiz.

Thank You for choosing LİTA Lighting

CE

TSE

EAC

1

Montaja başlamadan önce gövdeyi el ile çevirerek plakadan ayırın.
Seperate the body from the plate by turning the body manually before starting assembly.

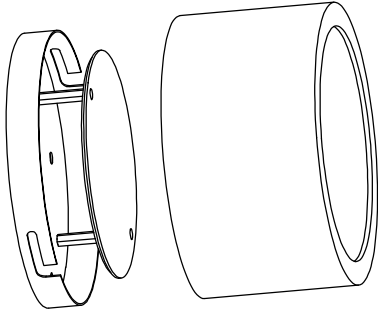

2

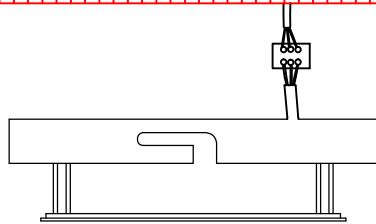

Elektrik bağlantısını yapınız.
Make electrical connections.

3

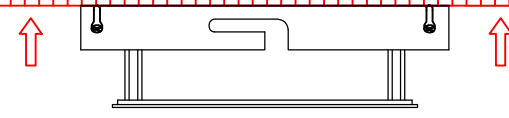

Vidalar yardımıyla plakayı tavana sabitleyiniz.
With the help of screws secure the bracket to ceiling plate.

4

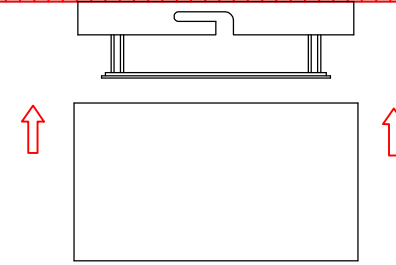

Gövdeyi el ile çevirerek plakaya sabitleyiniz.
Secure the plate by turning it with the hand the body.

5

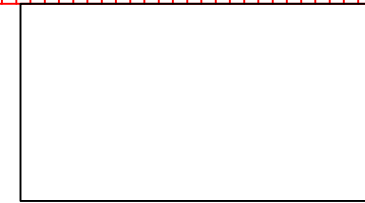

Armatür kapağının montajını yapınız.
Make the luminaire cover.